

SUK61MX9

Cooker size	60x60 cm
N. of cavities with energy label	1
Cavity heat source	Electric
Hob type	Gas
Type of main oven	Thermo-ventilated
Cleaning system main oven	Vapor Clean
EAN code	8017709268336
Energy efficiency class	A



Aesthetics



Series	Concert	Display	electronic 5 buttons
Aesthetics	Classic	Colour of buttons	Black
Colour	Stainless steel	No. of controls	6
Finishing	Brushed	Serigraphy colour	Black
Design	Standard	Handle	Smeg Classic
Door	With 2 horizontal strips	Handle Colour	Brushed stainless steel
Upstand	Yes	Glass type	Stopsol
Type of pan stands	Cast Iron	Feet	Silver
Hob colour	Stainless steel	Plinth	Black
Command panel finish	Stainless steel	Storage compartment	Door
Control knobs	Smeg Classic	Logo	Embossed
Controls colour	Stainless steel	Logo position	Facia below the oven

Programs / Functions

No. of cooking functions 6

Traditional cooking functions



Static



Fan assisted



Circulaire



ECO



Large grill



Fan assisted base

Cleaning functions



Vapor Clean

Hob technical features

UR			
Total no. of cook zones 4			
Front left - Gas - UR - 3.50 kW			
Rear left - Gas - Semi Rapid - 1.75 kW			
Rear right - Gas - Semi Rapid - 1.75 kW			
Front right - Gas - AUX - 1.00 kW			
Type of gas burners	Standard	Gas safety valves	Yes
Automatic electronic ignition	Yes	Burner caps	Matt black enamelled

Main Oven Technical Features



No. of lights	1	Removable inner door	Yes
Fan number	1	Total no. of door glasses	3
Net volume of the cavity	70 litres	No. of thermo-reflective door glasses	1
Gross volume, 1st cavity	79 l	Safety Thermostat	Yes
Cavity material	Easy clean enamel	Cooling system	Tangential
Shelf positions	5	Usable cavity space dimensions (HxWxD)	360X460X425 mm
Type of shelves	Metal racks	Temperature control	Electro-mechanical
Light type	Halogen	Lower heating element power	1200 W
Light power	40 W	Upper heating element - Power	1000 W
Cooking time setting	Start and Stop	Grill element	1700 W
Light when oven door is open	Yes	Large grill - Power	2700 W
Door opening	Flap down	Circular heating element - Power	2000 W
Removable door	Yes	Grill type	Electric
Full glass inner door	Yes		

Options Main Oven

Timer	Yes	Minimum Temperature	50 °C
End of cooking acoustic alarm	Yes	Maximum temperature	260 °C

Accessories included for Main Oven & Hob

Moka stand	1	40mm deep tray	1
Rack with back and side stop	1	Grill mesh	1

Electrical Connection

Plug	(G) UK e Singapore	Frequency	50/60 Hz
Nominal power	2900 W	Power supply cable length	120 cm
Current	13 A	Terminal block	3 poles
Voltage	220-240 V		

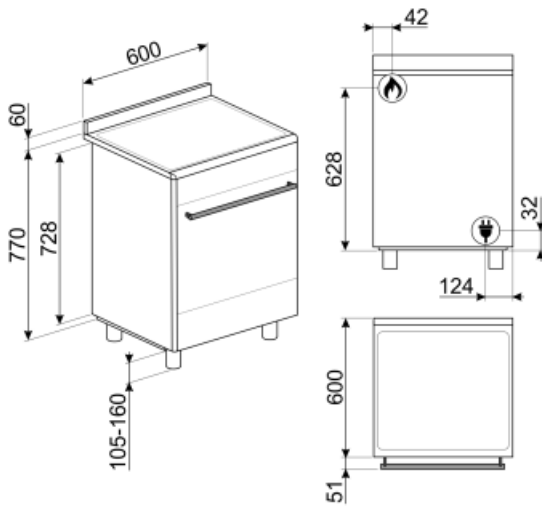

Not included accessories



PPX6090

Stainless steel grill plate suitable for 90 cm Concert cookers



SFLK1

Child lock



GTP

Partially extractable telescopic guides (1 level) Extraction: 300 mm Material: Stainless steel AISI 430 polished



KITP60X9

Splashback, 90 cm, stainless steel, suitable for pyrolytic Concert cookers



GTT



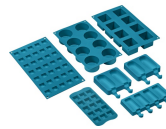















Totally extractable telescopic guides (1 level) Extraction: 433 mm Material: Stainless steel AISI 430 polished



SMOLD

Set of 7 silicone moulds for ice creams, ice lollies, pralines, ice cubes or to portion food. Usable from -60°C to +230°C

Symbols glossary

 <p>Heavy duty cast iron pan stands: for maximum stability and strength.</p>	 <p>Air cooling system: to ensure a safe surface temperatures.</p>
 <p>Triple glazed doors: Number of glazed doors.</p>	 <p>A: Product drying performance, measured from A+++ to D / G depending on the product family</p>
 <p>Enamel interior: The enamel interior of all Smeg ovens have a special antacid lining which helps keep the interior clean by reducing the amount of cooking grease adhering to it.</p>	 <p>Circogas: In gas ovens the fan distributes the heat quickly and evenly throughout the oven cavity, avoiding flavour transfer when cooking a number of different dishes at the same time. In electric ovens this combination completes cooking more quickly of foods that are ready on the surface, but that require more cooking inside, without further browning.</p>
 <p>Fan with upper and lower elements: The elements combined with the fan aim to provide more uniform heat, a similar method to conventional cooking, so pre-heat is required. Most suitable for items requiring slow cooking methods.</p>	 <p>Upper and lower element only: a traditional cooking method best suited for single items located in the centre of the oven. the top pf the oven will always be hottest. Ideal for roast, fruit cakes, bread etc.</p>
 <p>Circulaire: The combination of the fan and circular element around it gives a hot air cooking method. This provides many benefits including no preheat if cook time is more than 20 minutes, no flavour transfer when cooking different foods at the same time, less energy, and shorter cook times. Good for all types of food.</p>	 <p>ECO: The combination of the grill, fan and lower element is particularly suitable for cooking small quantities of food.</p>
 <p>Grill element: Using of grill gives excellent results when cooking meat of medium and small portions, especially when combined with a rotisserie (where possible). Also ideal for cooking sausages and bacon.</p>	 <p>All glass inner door: All glass inner door, a single flat surface which is simple to keep clean.</p>
 <p>The inner door glass: can be removed with a few quick movements for cleaning.</p>	 <p>Side lights: Two opposing side lights increase visibility inside the oven.</p>
 <p>The oven cavity has 5 different cooking levels.</p>	 <p>Ultra rapid burners: Powerful ultra rapid burners offer up to 5kw of power.</p>
 <p>Vapor Clean: a simple cleaning function using steam to loosen deposits in the oven cavity.</p>	 <p>The capacity indicates the amount of usable space in the oven cavity in litres.</p>